

Auger Products

Screw Conveyor Size Designation

The letter "H" indicates helicoid fighting screw conveyor, the letter "R" indicates ribbon fighting, the letter "S" indicates sectional fighting screw conveyor. The number to the left of the letters indicates the nominal outside diameter of the conveyor in inches. The first figure following the letters is diameter* of the couplings in inches. The next two figures indicate the nominal thickness of fighting at the outer edge in 1/64". The hand or spiral of a conveyor is indicated by "R" or "L" following the designation. In some cases there are another group of figures following the letters R and L. If this is the case, they are specifying the length of the auger (in feet and inches). If something special or different from standard (**).

Size designation:

Example: 9H412 R9-10-1/4 **

9 = screw diameter in inches

H = helicoid

R = ribbon

S = sectional

4 = 2 times 2" coupling shaft diameter *

12 = the nominal thickness of fighting at the outer edge in 1/64"

R = right hand (spiral)

9-10-1/4 = conveyor length (in feet and inches)

** = as desired (stated at right)

* Coupling Shaft Diameter:

2 = 1.0"

3 = 1-1/2"

4 = 2.0"

5 = 2-7/16"

6 = 3.0"

7 = 3-7/16"

**

SP = Short Pitch (2/3)

HP = Half Pitch (1/2)

LP = Long Pitch (1-1/2)

VPI = Variable Pitch (1/2 to Std.)

VP2 = Variable Pitch (2/3 to Std.)

DF = Double Flight

CW1 = Continuous welded one side

CW2 = Continuous welded both sides

Auger Fighting Capabilities

Helicoid Fighting	In.	(mm)	Sectional Fighting	In.	(mm)
1. Thinnest material thickness:	.093"	(2.4)	1. Thinnest material thickness:	.111"	(2.8)
2. Thickest material thickness:	.437"	(11.1)	2. Thickest material thickness:	.625"	(15.9)
3. Narrowest strip width:	.813"	(20.7)	3. Smallest O.D.:	2.937"	(74.6)
4. Widest strip width:	7.500"	(190.5)	4. Smallest Pitch:	2.625"	(66.7)
5. Smallest O.D.:	2.000"	(50.8)	5. Smallest I.D.:	1.000"	(25.4)
6. Shortest Pitch:	2.000"	(50.8)	6. Largest O.D.:	36.000"	(914.4)
7. Longest Pitch:	56.000"	(1,422.4)	7. Largest Pitch	24.000"	(609.6)
8. Smallest I.D.	.250"	(6.4)	8. Largest I.D.:	8.625"	(219.0)
9. Largest O.D.:	32.000"	(812.8)	9. Material grades: Carbon:	.15 thru .65	
10. Largest I.D.:	26.000"	(660.4)	Abrasion Resistant:	AR200 and AR400	
11. Material grades:			High Strength/Low Alloy:	A572, Gr50	
Carbon:	.04 thru .10		Stainless Steel:	304 and 316	
Stainless Steel:	304 and 409				

Custom Auger requirements are our specialty. We'll manufacture products to fit your product parameters, and demonstrate performance levels you expect from a quality supplier.

Special or unusual jobs or applications not covered in this data should be referred to DRIVES Product Manager.

If you have an auger that is different from these select sizes, please feel free to give us a call.

1-800-435-0782



Auger Products

Conveyor Screw Flighting

Screw conveyor flighting is made in either of two ways, as "helicoid" or "sectional" flights. Helicoid flights are formed from a flat bar or strip into a continuous helix. This flighting is thinner on the outer edge than on the inner edge. This process provides a continuous one-piece construction with a work-hardened, smooth finished flighting surface. Sectional flights are formed from a flat disc and the thickness of the flight is uniform. The lead of a sectional flight is slightly greater than one pitch. A continuous helix is made by joining a number of sectional flights together on a piece of pipe and butt welding them together.

Screw Flight Mounting

The metal helix of the screw, or the paddles used in lieu of a continuous helix, is mounted on either a hollow tube or a solid shaft. The hollow tube is normally Schedule 40 black steel pipe, but Schedule 80 pipe and mechanically drawn steel tubing sometimes are used. Occasionally a solid steel shaft is used for special conditions.

The pipe sections are bushed at the ends, and holes are drilled for the coupling bolts.

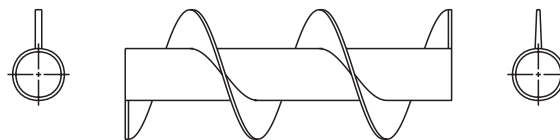

Basic Conveyor Flight and Pitch Types

STANDARD PITCH, SINGLE FLIGHT

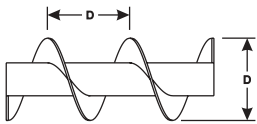

SHORT PITCH, SINGLE FLIGHT

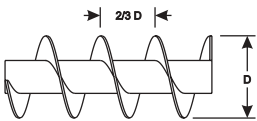

HALF PITCH, SINGLE FLIGHT

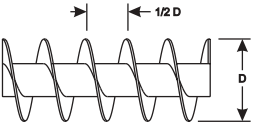

LONG PITCH, SINGLE FLIGHT

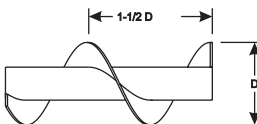

SINGLE FLIGHT, RIBBON

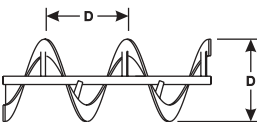

STANDARD PITCH, DOUBLE FLIGHT

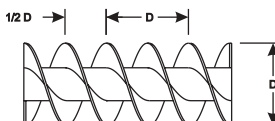

STANDARD PITCH, SINGLE FLIGHT

Conveyor screws with pitch equal to screw diameter are considered standard. They are suitable for a wide range of materials in most conventional applications.

SHORT PITCH, SINGLE FLIGHT

Flight pitch is reduced to 2/3 diameter. Recommended for inclined or vertical applications. Used in screw feeders. Shorter pitch retards flushing of materials which fluidize.

HALF PITCH, SINGLE FLIGHT

Similar to short pitch, except pitch is reduced to 1/2 standard pitch. Useful for vertical or inclined applications, for screw feeders and for handling extremely fluid materials.

LONG PITCH, SINGLE FLIGHT

Pitch is equal to 1-1/2 diameters. Useful for agitating fluid materials or for rapid movement of very free-flowing materials.

SINGLE FLIGHT RIBBON

Excellent for conveying sticky or viscous materials. Open space between flighting and pipe eliminates collection and build-up of the material.

STANDARD PITCH, DOUBLE FLIGHT

Standard pitch, double flight screws provide smooth, regular material flow and uniform movement of certain types of materials.

1-800-435-0782

DRIVES
INCORPORATED

Auger Products

Sectional Flight Conveyor Screws

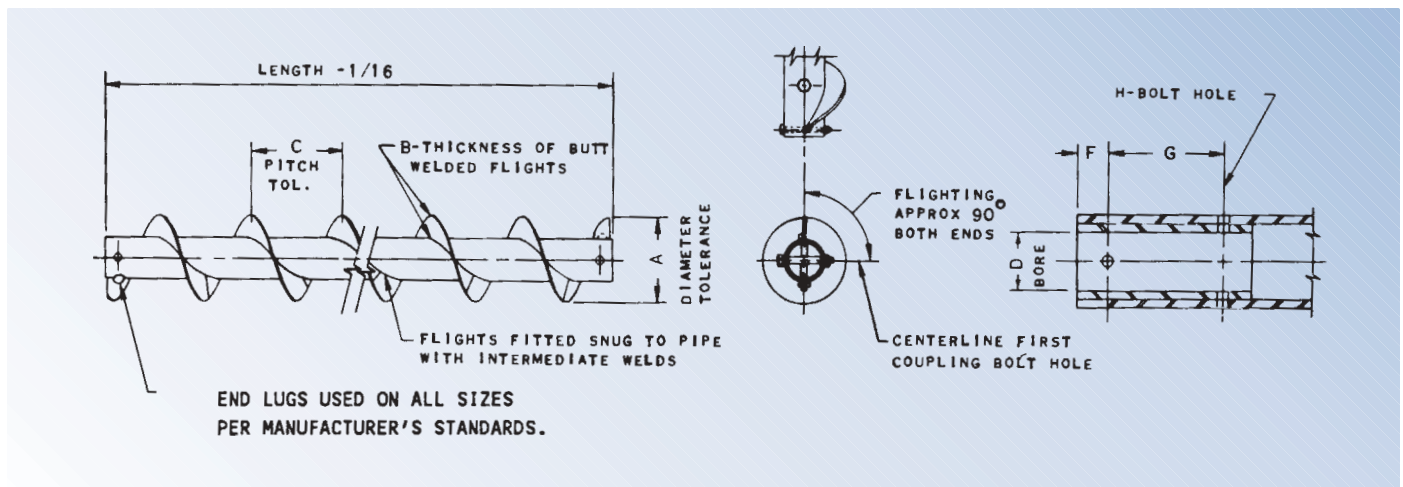

CEMA STANDARD NO. 300-002

Listed screw dia. and pitch	Cplg. Dia.	Size Designation	Pipe size sch. 40 inches	Length feet and inches	A		B	C		D		F	G	H
					Diameter tolerance		Flight Thickness	Pitch tolerance		Bushing bore inside diameter		Spacing 1st bolt hole	Centers 2nd bolt hole	Nom. bolt hole size
					Plus	Minus		Plus	Minus	Min.	Max.			
Inches					Inches									
6	1-1/2	6S209	2	9-10	1/16	3/16	10 Ga	3/8	1/4	1.505	1.516	7/8	3	17/32
	1-1/2	6S312	2	9-10	1/16	3/16	3/16	3/8	1/4	1.505	1.516	7/8	3	17/32
9	1-1/2	9S312	2	9-10	1/16	3/16	3/16	1/2	1/4	1.505	1.516	7/8	3	17/32
	2	9S412	2-1/2	9-10	1/16	3/16	3/16	1/2	1/4	2.005	2.016	7/8	3	21/32
	2	9S416	2-1/2	9-10	1/16	1/4	1/4	1/2	1/4	2.005	2.016	7/8	3	21/32
12	2	12S412	2-1/2	11-10	1/8	5/16	3/16	3/4	1/4	2.005	2.016	7/8	3	21/32
	2-7/16	12S512	3	11-9	1/8	5/16	3/16	3/4	1/4	2.443	2.458	15/16	3	21/32
	2-7/16	12S516	3	11-9	1/8	5/16	1/4	3/4	1/4	2.443	2.458	15/16	3	21/32
	3	12S616	3-1/2	11-9	1/8	5/16	1/4	3/4	1/4	3.005	3.025	1	3	25/32
	3	12S624	3-1/2	11-9	1/8	3/8	3/8	3/4	1/4	3.005	3.025	1	3	25/32
14	2-7/16	14S512	3	11-9	1/8	5/16	3/16	3/4	1/4	2.443	2.458	15/16	3	21/32
	3	14S616	3-1/2	11-9	1/8	5/16	1/4	3/4	1/4	3.005	3.025	1	3	25/32
	3	14S624	3-1/2	11-9	1/8	3/8	3/8	3/4	1/4	3.005	3.025	1	3	25/32
16	3	16S612	3-1/2	11-9	1/8	3/8	3/16	3/4	1/4	3.005	3.025	1	3	25/32
	3	16S616	3-1/2	11-9	1/8	3/8	1/4	3/4	1/4	3.005	3.025	1	3	25/32
	3	16S624	3-1/2	11-9	1/8	3/8	3/8	3/4	1/4	3.005	3.025	1	3	25/32
	3	16S632	3-1/2	11-9	1/8	1/2	1/2	3/4	1/4	3.005	3.025	1	3	25/32

Auger Products

Sectional Flight Conveyor Screws (Continued)

Listed screw dia. and pitch	Cplg. Dia.	Size Designation	Pipe size sch. 40 inches	Length feet and inches	A		B	C		D		F	G	H
					Diameter tolerance		Flight Thickness	Pitch tolerance		Bushing bore inside diameter		Spacing 1st bolt hole	Centers 2nd bolt hole	Nom. bolt hole size
					Plus	Minus		Plus	Minus	Min.	Max.			
Inches		Inches												
18	3	18S616	3-1/2	11-9	3/16	3/8	1/4	3/4	1/2	3.005	3.025	1	3	25/32
	3	18S624	3-1/2	11-9	3/16	3/8	3/8	3/4	1/2	3.005	3.025	1	3	25/32
	3	18S632	3-1/2	11-9	3/16	1/2	1/2	3/4	1/2	3.005	3.025	1	3	25/32
	3-7/16	18S716	4	11-8	3/16	3/8	1/4	3/4	1/2	3.443	3.467	1-1/2	4	29/32
	3-7/16	18S724	4	11-8	3/16	3/8	3/8	3/4	1/2	3.443	3.467	1-1/2	4	29/32
	3-7/16	18S732	4	11-8	3/16	1/2	1/2	3/4	1/2	3.443	3.467	1-1/2	4	29/32
20	3	20S616	3-1/2	11-9	3/16	3/8	1/4	7/8	1/2	3.005	3.025	1	3	25/32
	3	20S624	3-1/2	11-9	3/16	3/8	3/8	7/8	1/2	3.005	3.025	1	3	25/32
	3-7/16	20S716	4	11-8	3/16	3/8	1/4	7/8	1/2	3.443	3.467	1-1/2	4	29/32
	3-7/16	20S724	4	11-8	3/16	3/8	3/8	7/8	1/2	3.443	3.467	1-1/2	4	29/32
	3-7/16	20S732	4	11-8	3/16	1/2	1/2	7/8	1/2	3.443	3.467	1-1/2	4	29/32
24	3-7/16	24S716	4	11-8	3/16	3/8	1/4	7/8	1/2	3.443	3.467	1-1/2	4	29/32
	3-7/16	24S724	4	11-8	3/16	3/8	3/8	7/8	1/2	3.443	3.467	1-1/2	4	29/32
	3-7/16	24S732	4	11-8	3/16	1/2	1/2	7/8	1/2	3.443	3.467	1-1/2	4	29/32

Auger Products

Special Flight

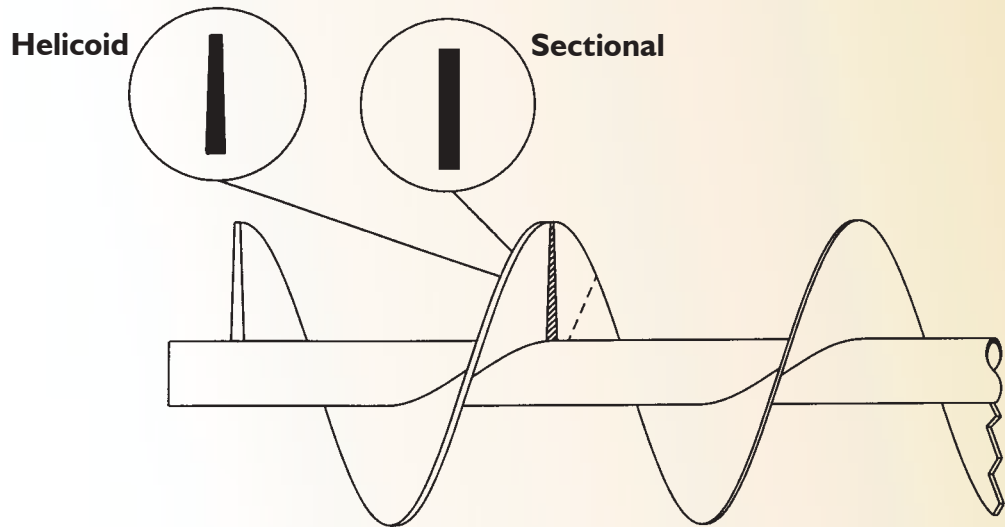

Manufacturer of:

USA ANSI

Power Transmission
Roller Chains

Conveyor Chain
Products

Pintle Chains

Auger Products

Engineering Class
Chains

Flight Design to Resist Wear

Sometimes special consideration needs to be given to the design of an auger assembly due to unusual wear or strength concerns. Most wear in a screw conveyor occurs at the intake, and sometimes at the discharge, when submerged in the conveyed material. One method of providing additional strength or wear life for a helicoid conveyor is to start the conveyor with one or more pitches of a sectional flight or a thicker helicoid flight. The illustration above shows how two augers can be joined and overlapped to give additional support and increased wear surface.

1-800-435-0782